

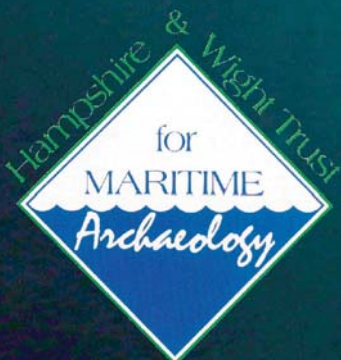

Needles and Alum Bay Dive Trail Project Report May 2005



ENGLISH HERITAGE



Contents

I. ACKNOWLEDGEMENTS.....	2
II. COPYRIGHT STATEMENT	2
III. AUTHORS.....	2
IV .LIST OF ILLUSTRATIONS	3
REPORT SUMMARY	4
1. PROJECT BACKGROUND AND RATIONALE	5
1.1 THE NEEDLES PROTECTED WRECK SITE & HMS POMONE.....	7
1.2 THE ALUM BAY I WRECK SITE.....	12
1.3 THE ALUM BAY II WRECK.....	15
1.4 THE WAY FORWARD	16
2. LEGAL AND ADMINISTRATIVE CONSIDERATIONS	17
PERMISSION TO ESTABLISH TRAILS.....	17
3. DESIGN, INSTALLATION & TESTING	19
3.1 THE NEEDLES SITE	19
3.2 ALUM BAY	27
4. LOGISTICAL AND RUNNING CONSIDERATIONS	37
4.1 RESEARCH AND PRODUCTION OF UNDERWATER BOOKLETS.....	37
4.2 THE DIVE TRAIL PACKAGE	37
4.3 THE DIVER TRAIL EXPERIENCE.....	38
4.4 LOGISTICAL CONSIDERATIONS.....	42
4.5 ADMINISTRATIVE CONSIDERATIONS	43
4.6 TRAIL MAINTENANCE CONSIDERATIONS.....	44
5. MARKETING	46
5.1 PROMOTIONAL MATERIALS.....	46
5.2 PROMOTIONAL EVENTS.....	47
5.3 ADVERTISING OPPORTUNITIES AND VENUES	48
5.4 TARGETED GROUPS	49
5.5 INTERNET AND EMAIL ADVERTISING.....	49
6. THE FUTURE FOR SOLENT DIVE TRAILS	51
6.1 LESSONS LEARNT.....	51
6.2 TAKING THE SOLENT DIVE TRAILS INITIATIVE FURTHER	51
6.3 SPREADING THE WORD.....	51
7. REFERENCES	52
8. APPENDICES.....	53
8.1 HWTMA GRANTS AND DONATIONS 2003/4	53
8.2 HWTMA POLICY STATEMENTS	54
8.3 EXTRACT FROM ALUM BAY UNDERWATER BOOKLET	56
8.4 DIVE TRAIL EVALUATION QUESTIONNAIRE	57

i. Acknowledgements

The design, installation and testing of the Needles and Alum Bay Dive Trails has been generously funded by English Heritage and Leader +. Aspects of the project have received additional funding from the Local Heritage Initiative.

The project has utilised archaeological work undertaken over the past twenty years of the Needles Protected Wreck site and Alum Bay sites. The discovery of wreckage on the Needles site was by Derek Williams, subsequent work was undertaken by Martin Woodward, the main excavation was undertaken by John Bingeman and his team. The HWTMA has continued to survey and monitor the Needles wreck site since its formation in 1991. Work on the Alum Bay sites has been undertaken by the HWTMA since the initial discovery of the Alum Bay I site by Steve Robbins in 1991.

The HWTMA would like to acknowledge the support of all our sponsors who have contributed to the work of the Trust, particularly to maritime investigations in and around Alum Bay and the Needles. A list of organisations who have supported the HWTMA during 2003/4 is included as Appendix 8.1.

ii. Copyright statement

This report has been produced by the Hampshire & Wight Trust for Maritime Archaeology. All text, images and intellectual content of this report are copyright © 2005 of the HWTMA unless otherwise stated. All rights expressly reserved.

Project sponsors are granted permission to use report text or images collected during the 2003/ 04 projects for their own use as desired.

iii. Authors

This report has been written and produced by Julie Satchell (Archaeological Officer) with contributions from Garry Momber (Director), Claire Campbell (Project Officer) and Jan Gillespie (Project Officer).

Design of the Dive Trail publicity material has been completed by Rebecca Causer, (Project Officer). Image management by Julian Jansen van Rensburg (Project Officer)

iv .List of illustrations

Figure 0A – Photograph showing yachts moored in Alum Bay with the Needles in the background

Section One

Figure 1A - Divers experience the Warship Hazardous Diver Trail

Figure 1B - Map showing position of Alum Bay and the Needles

Figure 1C - The Needles from the Air

Figure 1D – Intaglio from the *Pomone* site (© Needles Project)

Figure 1E - Coin from the *Assurance* site (© Needles Project)

Figure 1F – Cast iron ballast block from the *Pomone* site (© Needles Project)

Figure 1G - Artists impression of the wrecking of the *Pomone*

Figure 1H - Plan of *Pomone* with position of loss

Figure 1I - Diver hammering in datum on the Needles site

Figure 1J – Model of seabed topography around the Needles

Figure 1K - Image of Alum Bay I showing timber structure and fittings

Figure 1L - The lead lined hawse holes

Figure 1M - Alum Bay I site plan

Figure 1N - Alum Bay II wreck structure

Figure 1O - Alum Bay II wreck plan

Section Three

Figure 3A - Dive boats over the Needles site during SoIMAP

Figure 3B – The dramatic Needles wreck site

Figure 3C - Chalk gullies off the Needles

Figure 3D - Lead shot in gully

Figure 3E - Diver inspects the anchors from *Pomone*

Figure 3F - Iron knees to the north of the Needles site

Figure 3G - Diagram showing the Dive Trail sinkers and line

Figure 3H – Test Dive Trail board on the Needles

Figure 3I - Trail stations in relation to the Needles site

Figure 3J - Diver planning the Alum Bay I wreck

Figure 3K - Divers onboard in Alum Bay

Figure 3L - Alum Bay I wreck site

Figure 3M - Alum Bay II wreck site

Figure 3N – Marine life found on the Alum Bay Dive Trail

Figure 3O - The four types of trail marker trialled in Alum Bay

Figure 3P - Initial Alum Bay Dive Trail route

Figure 3Q - The final Alum Bay Dive Trail route

Section Four

Figure 4A Entrance to the Fort Victoria Maritime Heritage Exhibition

Figure 4B Example displays at the Maritime Heritage Exhibition

Section Five

Figure 5A - Extract from Dive Trail marketing leaflet

Figure 5B - Dive Trail promotional poster and panel

Figure 5C - Dive Trail web pages

Report Summary

This report details the experiences of the HWTMA in the design, implementation, testing, marketing and promotion of Dive Trails on two sites off the north west coast of the Isle of Wight, England. This project has been kindly sponsored by English Heritage and Leader +.

This report has been produced to make available the detailed results of the project, it is hoped that other groups or organisations considering establishing Dive Trails will find this useful.

Section 1 outlines the rationale behind the establishment of the Dive Trails and presents background information detailing the history of the vessels, the wreck sites and the archaeology undertaken on them.

Aspects of project planning are detailed, such as the legal and administrative considerations for the trails. The practical aspects of the design and installation of the Dive Trails are then explored. Details of the materials used, trail routes and underwater booklets are outlined.

Logistical and running considerations form section 4 of this report, here an explanation of the dive trail experience outlines the itinerary for the Dive Trail day. This includes details of the different types of Dive Trail package on offer to divers and non-divers.

Approaches to publicity and marketing are discussed in section 5. The variety of materials produced, advertising undertaken and marketing opportunities available are explored.

Finally, in section 6, we explore 'The future for Solent Dive Trails'. This looks at how the initiative could be utilised in other areas of the region. It also mentions future plans for a formal publication.



Figure 0A – Photograph showing yachts moored in Alum Bay with the Needles in the background

1. Project background and rationale

Presenting submerged cultural heritage

Since 1991 the Hampshire and Wight Trust for Maritime Archaeology (HWTMA) has been working to research the submerged cultural heritage of the Solent and Sea Wight area. One of the primary aims of the HWTMA is to present the results of this research to a wide audience. The HWTMA encourages the active participation of volunteers and divers, and engages in a programme of outreach, education and dissemination. This programme directly involves individuals in the archaeological investigation of the submerged and intertidal heritage resource. In addition the results of our projects reach an audience of tens of thousands of people per year through the Maritime Heritage Exhibition at Fort Victoria, temporary displays around the region, talks, presentations and activity days.

The HWTMA approach is one of continual and proactive dissemination, endeavouring to increase the number of people directly involved in maritime archaeology while opening up the results of research to the widest audience. We have developed a proactive education policy which embodies our aspirations for outreach to a broad audience (see appendix 8.2 for a summary of our education policy). Establishing and running dive trails fits this strategy through the active engagement of divers and providing further information for non-divers via the World Wide Web, the media, publications and talks.

Formation of the dive trail model

The work of volunteer divers on archaeological sites has proved very valuable and has helped the HWTMA's survey, excavation and recording of sites. In addition, divers involved in projects acquire a personal appreciation of our cultural heritage and the process of extracting information from submerged archaeological sites. Divers and non-divers who could not be accommodated on research projects were keen to learn about a world they could not experience at first hand.

Dive trails have been identified as a mechanism that could help achieve this goal and consequently the HWTMA introduced a dive line on the Needles Protected Wreck Site in the late 1990s. The concept was pursued off West Sussex and resulted in the creation of an underwater dive trail on the Protected Wreck Site of the warship *Hazardous* in collaboration with the *Hazardous* project team. The Dive Trail experience includes presentations, a guided tour around the trail and a visit to the artefact collection and display. A booklet on the Dive Trail and shipwreck has been produced to accompany the project.

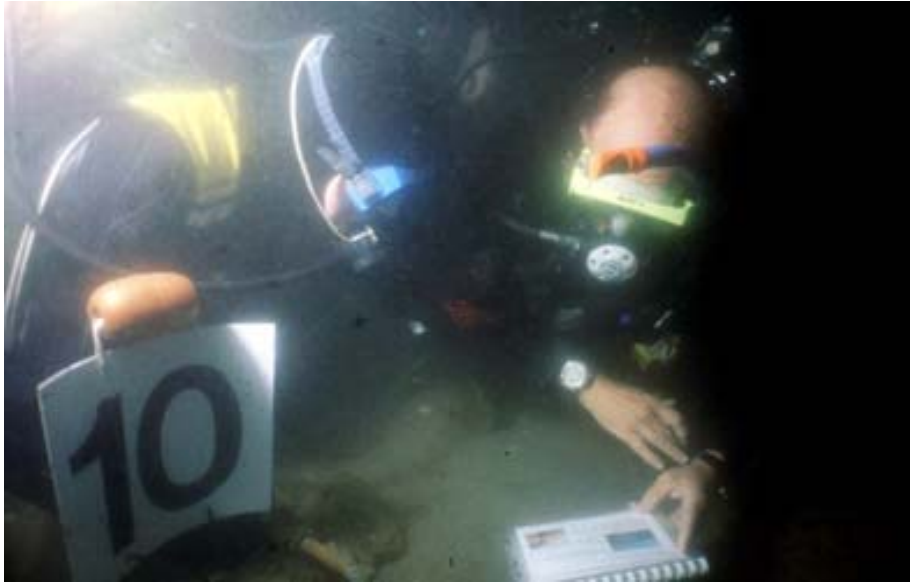

Figure 1A - Divers experience the Warship Hazardous Diver Trail

Reaching a wider constituency

It has been recognised that many people who cannot dive are very keen to have access to wreck sites. Likewise, many people are fascinated by maritime archaeology but often have little understanding of the discipline. These, non-diving public constitute a huge audience for which to provide information about otherwise inaccessible wreck sites.

It is clear that the establishment of a 'Dive Trail' should be used to present information to this wider public in addition to divers. The need for a variety of methods of presentation and dissemination added another dimension to the planning and execution of the Needles and Alum Bay Diver Trails.

An inspiring marine environment and resource

The decision to use the Needles and Alum Bay sites for the development of Dive Trails was based on a variety of factors. The two locations provide differing environments for divers; the dynamic Needles is a challenging and unpredictable environment while Alum Bay is sheltered and usually calm waters.



Figure 1B - Map showing position of Alum Bay and the Needles

The other principle factor involved was the knowledge of the wreck sites. Extensive research and investigation has been undertaken over the past twenty years which has resulted in an archive of information available for the project. Sections 1.1, 1.2 and 1.3 introduce the archaeological background to the sites, on which the Dive Trail experience is based.

1.1 The Needles Protected Wreck Site & HMS Pomone

The Needles lie at the end of a large chalk outcrop running west from the Isle of Wight. They are the remnants of a ridge that once crossed Christchurch Bay to Handfast Point on the Isle of Purbeck. Over time chalk stacks have been formed, eroded and collapsed leaving concealed hazards just below the water. It is upon these that vessels of all sizes have come to grief.



Figure 1C - The Needles from the Air

Search and recovery of artefacts from ships lost on the Needles began in 1969 following the discovery of a large assemblage of shipwreck material by Derek Williams. His discoveries, supplemented by those of Martin Woodward and John Bingeman, suggested a number of shipwrecks.

The wreck site

Since the discovery of the wreck site in 1969 over 3,000 items have been excavated, recorded and surveyed. The wreckage lies within an overall depth range of 3-10m on a submerged wave-cut platform terminated to the north by an underwater cliff. It is an area of sharp eroded chalk gullies and ridges, formed into east-west aligned channels along the remains of the former chalk ridge. The site is west facing and subject to the full onslaught of the prevailing weather and a fetch that traverses the Atlantic Ocean. Due to the exposed nature of the wreck site, very little organic material remains and all the ships structure has been dispersed.



Figure 1D – Intaglio from the Pomone site (© Needles Project)

Identifying the wrecks

Ordnance and numismatic evidence gathered in the early years testified a British naval vessel operating in the region of the Spanish-American colonies. This and further finds fitted the profile of the 44-gun *Assurance* lost on the return journey from Jamaica in 1753. The ship was returning with the retiring Governor, Edward Trelawny, when it was claimed by the Needles Reef on 24th April. Accordingly, the site was designated the *Assurance Protected Wreck Site* under the 1973 Act in 1975.



Figure 1E - Coin from the Assurance site (© Needles Project)

Work on the site continued in 1977 and 1978 when a team from the Portsmouth Royal Naval Sub-Aqua Club conducted detailed surveys. Survey lead to a revised interpretation which included two distinct events, the majority of wreckage being from *HMS Pomone* while the *HMS Assurance* lay to the north.



Figure 1F – Cast iron ballast block from the Pomone site (© Needles Project)

The loss of *HMS Pomone*

HMS Pomone was a Leda class 38 gun frigate, constructed in 1805 at Frinsbury near Chatham. The ship was returning from the Mediterranean after five years at sea with important intelligence for the King of England. Passengers onboard included Sir Harford Jones, the retiring English Ambassador to Persia along with his colleague, Major-General Sir James

Sutherland who was acting as escort to two young Persian princes from Azerbaijan. During stopovers at Malta and Sardinia, meetings of great importance were attended and further sensitive documents were collected for the attention of the Foreign Secretary. The *Pomone* left Sardinia in haste to fulfil the errand but it was this haste that enticed then to take the western channel and the Needles.



Figure 1G - Artists impression of the wrecking of the *Pomone*

HMS *Pomone* struck the Needles in the evening of 14th October 1811. The ship was holed and wedged between the submerged Goose Rock and the outermost Needle. Fortunately, the winds were light, although this did not dispel the belief by some members of the crew that they were witnessing their last hours. In an effort to combat their fears they turned to the ship's rum ration only to have their antics recorded by Sir Harford Jones. Their fears were unwarranted as the ship's flares were seen from Yarmouth and by the end of the night all 283 officers and crew plus passengers were rescued by local pilot vessels (jolly boats) and boats of the guard ship *Tisiphone*. It should also be noted that many of the ship's contents were 'liberated from the sea' by local boatmen as it broke up over the following days!

Continuing site investigation

Active survey and excavation in the gullies around the site continued to see artefacts raised into the 1980's. In total, some 98% were eventually attributed to the wreck of the *Pomone*. With the identity of the vessel known, attention was drawn to their distribution as core to understanding the wrecking process. All the coherent structure had been lost and it initially appeared that the finds were randomly strewn or 'scrambled' but when their locations were added to the *Pomone* database, distinct patterning became apparent. Notwithstanding the wreck being entirely broken up, the artefacts had become trapped in the gullies and potholes in the seabed where many had very little opportunity to move. By studying their distribution and by drawing correlations with the identifiable ships' fittings and the documented wrecking event, it was eventually possible to reconstruct the approximate position and orientation of the settled vessel.

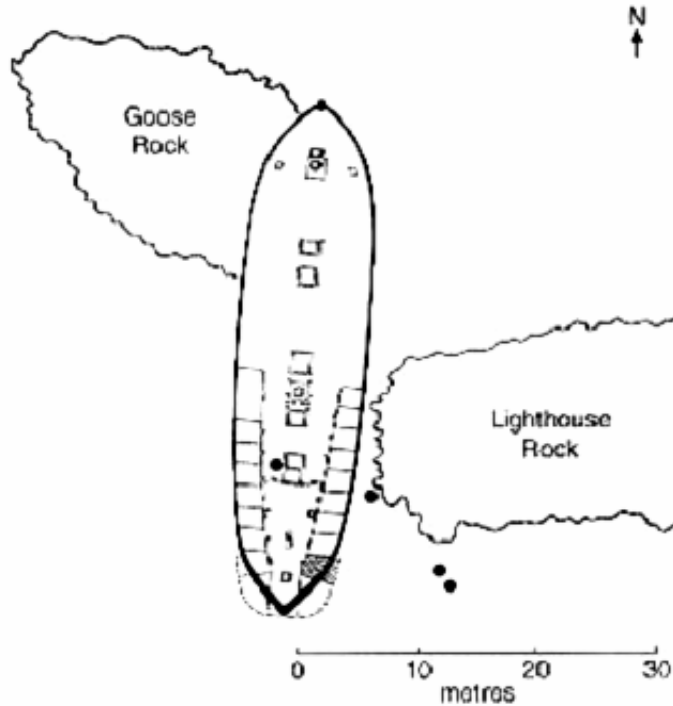

Figure 1H - Plan of Pomone with position of loss

In 1992 collaboration between the HWTMA, the County Archaeologist and the Nautical Archaeology Society (NAS) saw a team return to the site with a new brief: 'to produce a detailed topographical survey in order to model and analyse the environmental mechanisms and their interaction with the ship'. The rationale was to correlate the artefact distribution with the known ship design. This would provide a valuable insight into the wrecking process of ships in similar circumstances.



Figure 1I - Diver hammering in datum on the Needles site

Work continued through the 1990's, steadily building a 3 dimensional network of measurements. The methods proved successful although the large and irregular height variations of the gullies and exposure to swell in a fast running tide made work difficult and time consuming. In 1997 technology provided the

answer when the HWTMA organised a survey in conjunction with Submetrix UK Ltd. The survey tool used was the ISIS 100 (Interferometric Seabed Inspection Sonar), Swath Bathymetry system. This provided a model of the seabed topography to help understand the distribution of material derived from the wreck of the *Pomone* and to provide a template upon which a dive line or trail could be placed.

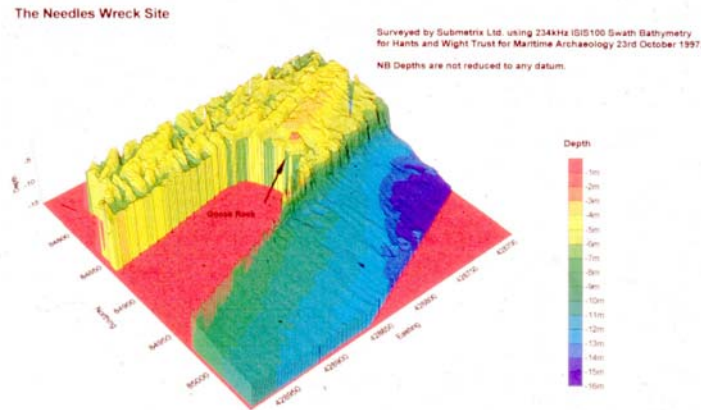

Figure 1J – Model of seabed topography around the Needles (© Submetrix/ SEA)

1.2 The Alum Bay I wreck site

A large section of wooden hull was brought to the attention of the Isle of Wight County Archaeological Centre by Steve Robbins in 1991. The wreckage lay in 7m of water tucked amongst the reefs of Alum Bay in an area of fine sand. It appeared cohesive with iron fastenings and numerous copper pins projecting from the seabed.

Early in 1993 it was proposed that the HWTMA take a primary role in co-ordinating work on the site. A core team brought together NAS trained divers from the Isle of Wight and the RAF Odiham diving club to conduct an evaluation survey during the spring of that year. The survey recorded copper pins, two rows of irons knees or deck supports and two large hawse holes within an area of wooden structure over 20m long and 4m wide.

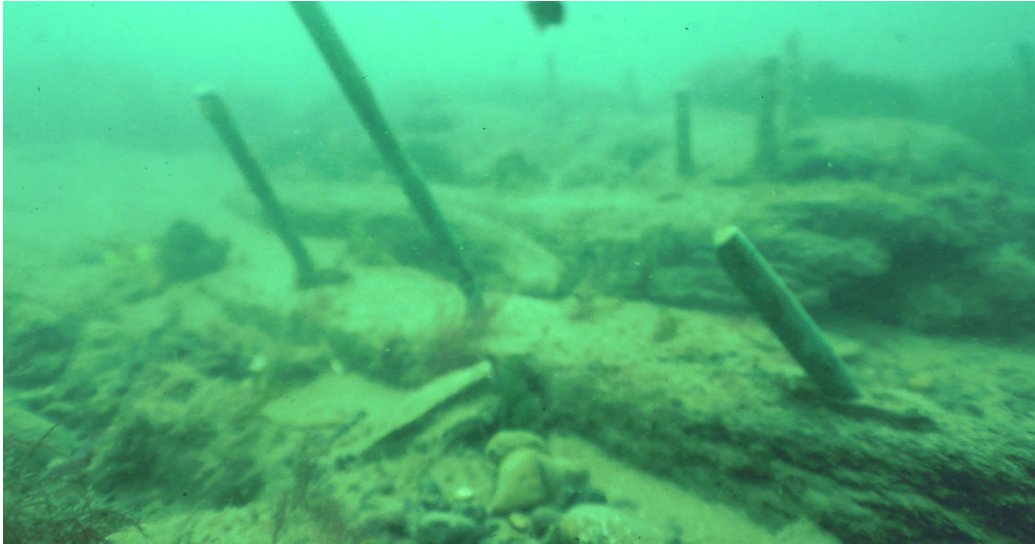

Figure 1K - Image of Alum Bay I showing timber structure and fittings

The remains appeared to be that of the upper, port section of a wooden vessel lying with the external planking face down in the seabed, oriented north-west to south-east. The visible features elevated above the seafloor were the internal fixtures and fittings. The lines of knees and iron supports running down the length of the vessel signified the remains of decks while the hawse holes, through which the anchor chain and ropes passed, indicated the bow at the north east end. The structure lies relatively flat on the seabed with all the timbers interpreted as frames, broken along the south-west extremities. This may be an area around or just above the turn of the bilge where this port section may have parted company from the lower hull.

Identifying the wreck

A number of diagnostic features that helped present a time frame for the loss of the vessel were identified during the survey. These included a sheet of copper sheathing protruding from the underside of the vessel near the bow, copper alloy bolts, lead hawse holes, iron knees and broad arrows on the copper bolts.



Figure 1L - The lead lined hawse holes

The evidence indicated that the wreckage was part of a substantial vessel built somewhere around the beginning of the nineteenth century, possibly naval, that was wrecked in or around Alum Bay. Marrying these facts against known ship losses presented possibilities although the data was not sufficient for confirmation. More work was necessary if the true identity of the mystery wreck was to be resolved.

Site survey and excavation

The 1993 fieldwork was continued in the summer of 1998 as part of the first year of the Solent Maritime Archaeology Project (SoIMAP), the aim was to survey and plan the whole site using planning frames. This work and that in subsequent seasons resulted in the production of a full site plan.

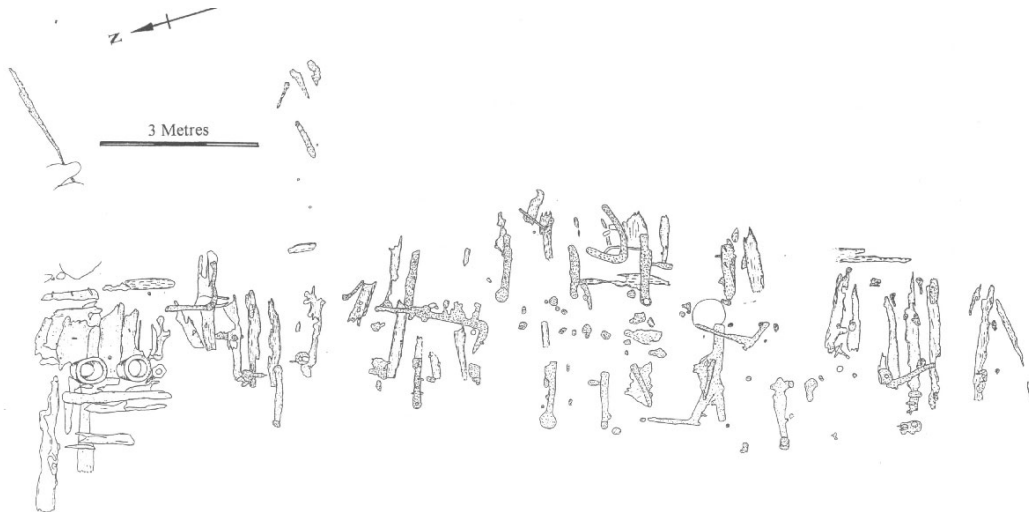

Figure 1M - Alum Bay I site plan

On completion of the survey, the identity of the wreck was still uncertain so areas were selected for excavation to help resolve this longstanding question.

Removal of the sand revealed components of the ships hull which were measured and compared to the plan of a Leda Class frigate. The match was striking. These similarities and the weight of evidence from other finds which include broad arrows on copper pins and structural elements, lead us to conclude that the wreck was that of HMS *Pomone*.

1.3 The Alum Bay II wreck

New Dawn Divers brought an inverted section of wooden hull measuring 12m in length to the attention of the HWTMA in 2000. The structure is lighter in construction than its neighbour, Alum Bay I, which lies some 60m to the east.

Survey

The structure lies upside down with an area of planking and the keel exposed. Floor timbers and frames are clearly visible and limber holes, which have been cut into the frames either side of the keel, can be seen where the outer planking is eroded. The surviving hull planking appears to be in an excellent state of preservation. This is due to the fine sand which crosses the site, both protecting it from infestation while possibly smoothing any rough surface by gentle abrasion. A varying thickness of sand is witnessed on the wreck throughout the diving season.



Figure 1N - Alum Bay II wreck structure

During 2001 and 2002 the site was planned. The survey has established baseline data that is being used for the future management. This plan has been valuable when monitoring disturbance and now forms the basis to the diver trails.

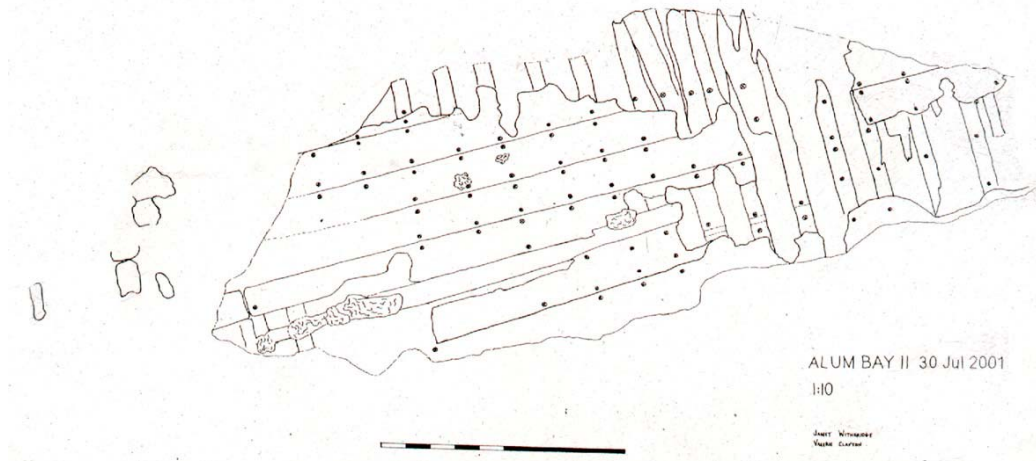

Figure 10 - Alum Bay II wreck plan

1.4 The way forward

The years of archaeological research summarised above have provided the backdrop against which the HWTMA has developed the Dive Trail initiative. A clear set of aims and objectives were formulated in response to the need to increase opportunities for guided access to historic wreck sites by divers and non-divers.

Project Aim

To enable members of the public to gain an understanding and appreciation of historic wreck sites through a variety of media.

Project Objectives

- To foster the sustainable promotion of the historic wreck resource
- Provide divers access to historic sites through controlled management
- Provide non-diving members of the public with informative and memorable experiences of historic wrecks

Principle project components

The Dive Trail project consists of a number of interactive components, they include:

- Establishment of dive trails on the Needles and Alum Bay site
- Production of underwater booklets to act as diver guides
- Production of an introductory presentation for all Dive Trail participants which includes information on the history of the sites, archaeological investigations and video footage
- Inclusion of display materials in Fort Victoria Maritime Heritage Exhibition relevant to the dive trail experience
- Development of marketing and promotional materials
- Development of Dive Trail webpages which include video footage

2. Legal and Administrative Considerations

Prior to establishing the dive trails a number of legal and administrative permissions were required. Many of the permissions are common to both the Needles and Alum Bay sites, although, as the Needles is a protected wreck site additional considerations were necessary.

Permission to establish trails

All areas of seabed have an owner, if considering installing a diver trail the permission of the landowner is required. In addition to the seabed having an owner a wreck site may also have an owner, this could be the original vessel owner, an insurance company, a salvage company or anyone who has purchased a sunken vessel.

Crown Estate

The initial 'port of call' for permission to establish the trail was with the Crown Estate. The Crown Estate owns much of the seabed around Britain, taking an active role in its management and stewardship.

The Crown Estate were keen to know what the proposed Dive Trail consists of and how it would operate. The primary concern was to ensure best practice and clarification of responsibilities.

DCMS - Protected wreck site

The Needles site is designated under the Protection of Wrecks Act 1973 and as such requires special permission from the Department of Culture Media and Sport in order to be able to establish a diver trail.

Permission to lay a line around the site was in place by 1999 when divers were using it to help navigate themselves around the gullies during work on the site.

Subsequent licence applications in relation to the dive trail have involved the annual granting of a 'Visitor Licence' for the site. The HWTMA also holds licenses for survey and for surface recovery of artefacts which are at risk of loss. This combination of licences has enabled the establishment, testing and operation of the dive trail.

English Nature

The Needles and Alum Bay sites lie partially within the South Wight Marine Special Area of Conservation. They are also adjacent to the Headon Warren and West High Down SSSI area which is home to a variety of nesting birds, including Herring Gulls, Cormorants, Fulmars, Kittiwakes, Shags, Razor Bills and Puffins.

English Nature were contacted in relation to the Dive Trail. While the trail itself does not threaten to impact on the natural resource of the area, concern was raised over the potential for increased boat traffic close to cliffs during the nesting season. To mitigate these impacts, literature sent to Dive Trail participants will include information highlighting the presence of nesting birds and outline appropriate behaviour in proximity to them.

Buoyage - Trinity House

Trinity House are responsible for the safety of shipping and well-being of sea farers. They oversee lighthouses, buoyage and aids to navigation around the UK. As the Dive Trails require the establishment of buoys on site for the summer season, Trinity House were contacted in relation to any issues or regulations which they may fall under.

The response from Trinity House indicated that they did not have any particular concerns about the placing of a buoy on site. They did require information on the type of buoy it would be and when it would be installed.

3. Design, installation & testing

3.1 The Needles Site

Work to install a Dive Trail on the Needles site first began in 1999 when a line was laid to aid divers movement around the site. The seabed topography is made up of numerous chalk gullies and can be confusing to divers unfamiliar with the site. Work on this site has posed interesting challenges due to the special nature of the site conditions and its archaeology.

Description of the project

Experience during the HWTMA western Solent Marine Archaeology Project (SolMAP) in 1997 and 1998 demonstrated that diving on the Needles wreck site can be a confusing experience for those who do not know it. This prompted the placing of a line on the site in 1998 to facilitate passage around the main features. This greatly aided navigation and increased productivity allowing divers to get to their place of work with ease.



Figure 3A - Dive boats over the Needles site during SolMAP

Subsequently in 2000 sections of this line were replaced by a more visible material and further 'sinkers' or 'stations' deployed to hold them in place. During the 2001 and 2003 seasons diving on the Needles site was infrequent due to poor weather conditions which meant planned refinements of the 'proto' dive trail were unable to occur.

During the 2004 season, as part of the Leader+ / EH funded project further diving was undertaken in order to enhance the sections of line and to test a diver trail route and booklet.

3.1.1 Site Characteristics

Environmental conditions

Guarding the western entrance to the Solent the Needles occupy an important strategic position. The Needles can be a challenging area to dive. Being exposed to the extremes of wind, weather and tide. These conditions have been the cause of many shipwrecks which, in turn, have made the site such an interesting dive today.



Figure 3B – The dramatic Needles wreck site

The tidal regime at the Needles site can be extreme, particularly during spring tides when the slack water period is limited to about 40 minutes. The funnelling effects of the western Solent mean that water is either being forced into the narrow Needles channel or racing out on the ebb tide. Spring tides occur every two weeks these higher high tides and lower low tides mean increased water movement. The faster water currents move and transport more sediment in the water column, this reduces the chances of good visibility and the length of viable diving time on site.

During neap tides there is an opportunity to take advantage of longer periods of slack water of about 90 minutes, it is particularly good to dive the site on the high water slack. With little water movement and optimum weather conditions there can be eight to ten metres visibility on site.

The weather can have a significant effect on the diving conditions. A south westerly wind will quickly increase swell and pick up wave heights at the surface making dive preparation uncomfortable and potentially more hazardous. Underwater, the surge can quickly increase as some parts of the site are only six metres deep and this can soon make diving difficult and dangerous.

One of the principle problems caused by windy weather conditions is the deployment and recovery of divers. It is difficult for hard boats to approach close into the Needles due to the submerged reefs that lie just under the surface. This means that divers have to propel themselves away from the Needles towards deeper water. One of the best ways for accessing the site is using a Ridged Inflatable Boat (RIB) as they have the ability to get much closer to the site.

A further consideration is the frequency of boat traffic. The area forms the extreme western point of the Isle of Wight and is often used as a marker for boats which turn around the Needles. The area is also used extensively by small craft fishing with rods or laying lobster pots.

Despite the variable environmental conditions on site the Needles remains one of the most dramatic places to dive around the south coast of Britain. The site is considered suitable for the more advanced diver.

Seabed and Geology

The defining features of the Needles are the chalk pinnacles and their adjacent gullies. This landscape forms an unusual environment in which to dive.

The Needles form the western extreme of a ridge of chalk which runs east - west across the Isle of Wight. This ridge once extended across what is now the western entrance to the Solent to the Dorset coast. Rising sea levels over the last 15,000 years eroded this ridge to form Christchurch Bay and the western Solent.



Figure 3C - Chalk gullies off the Needles

The chalk gullies dominate the underwater landscape; some of these gullies are several metres deep. To the north of the Needles site there is a particularly impressive drop off, this marks the edge of the chalk platform.

The harsh tidal regime in the area means that there is little sediment covering over much of the seabed. However, in the base of the gullies there can be an accumulation of deposits. These are mostly coarse-grained materials and are dominated by pebbles and stones.

The environmental conditions and geology have shaped the wrecking process of the vessels lost here. This has had a dramatic effect on the nature and preservation of archaeological materials discovered.

Archaeology

As outlined in section (1.1) there has been a history of archaeological investigation around the Needles site. Two such investigations were the excavation of the *Campen* site in the 1970's (Larn 1985) and the *Pomone/Assurance* site in the late 1970's and 80's (Tomalin et al 2000).

The majority of artefacts recovered during these investigations were large and robust objects that best withstood lengthy exposure and were visible close to the seabed surface. Artefacts excavated from areas of deeper sediment, usually in the base of gullies or in pockets in the chalk, were predominantly metal; some of these have survived well. Organic materials did not survive as well due to the paucity of sediment covering; this meant little or no protection from water movement or biological organisms.

Today on the Needles site a variety of artefacts can still be seen. Of particular note are the carronades and anchors from HMS *Pomone*, the ballast blocks from the *Anglo Saxon* (sunk 1879), along with numerous other instances of iron or lead shot.



Figure 3D - Lead shot in gully



Figure 3E - Diver inspects the anchors from Pomone

Investigations to the north and east of the main wreck site are continuing to reveal further evidence of shipwreck material. This includes a group of iron knees, possibly from the Pomone, discovered during 2002. Occasionally the mobile sediments reveal new artefacts, which, if deemed to be at risk of loss they are surveyed and recovered.



Figure 3F - Iron knees to the north of the Needles site

Marine Life and Habitats

The experience of diving on the Needles site is enhanced by the diversity of marine life which makes its home within the chalk gullies. One of the most dramatic creatures to be seen are the conger eels which use the sheltered crevices of the gullies to make their home.

The Needles site lies partially within the South Wight Marine Special Area of Conservation. This area is designated for the reefs and submerged or partially submerged sea caves. The chalk ridges off the Isle of Wight of which the Needles are part, contain some of the most important subtidal British chalk reefs representing over 5% of Europe's coastal chalk exposures. They support a diverse range of species in both the subtidal and intertidal zones (Joint Nature Conservation Committee 2004).

Enjoyment of the marine environment and biological diversity is a principal part of the Dive Trail experience.

3.1.2 Deploying the trail

Route

Deployment of a suitable dive line on the Needles has taken a number of diving seasons. The extreme environmental factors and level of exposure witnessed at the Needles has been the major influence when setting down a trail. Initially the line laid on site consisted of plastic coated marine cable. This ran from the Southern side of the Needles along the western edge of Needles rock and looped around Goose Rock. Unfortunately, storms in 1999 lifted the cable over the top of Goose Rock (over 7m in height), leaving it in a tangle to the east side.

The dive line was reconfigured in 2003 when it was integrated more closely with the seabed. This means that the line is often protected from some of the worst weather conditions as it is sheltered within gullies or in the lee of larger chalk features.

The Dive Line

The majority of the diver trail route is now marked with a visible blue covered line. The line is made from twisted steel cable encased in a blue plastic covering. This line has been utilised on the Warship *Hazardous* Dive Trail since 2000 and has proved to be hard wearing and easy to follow although occasional cleaning of biological growth is necessary.

Fixing the line

On the dynamic Needles site we have used sinkers made of iron encased in concrete to hold the trail in place. The line is divided into sections of cable that vary from between seven to fifteen metres in length. The line is fixed to markers by forming a loop in the end of the cable that is fixed to a hook on the concrete sinker.

The sinkers weigh around 40kg each. They have an iron ring in the top which allows the attachment of sections of line and station markers. They also form the base stations for several of the dive trail station markers.



Figure 3G - Diagram showing the Dive Trail sinkers and line

3.1.3 Testing and establishing marker stations

Initial tests

In 2000 the first trial marker station was placed on the Needles site. This consisted of a white perspex underwater board with information about the site and a plan. The board was fixed to a sinker with industrial size cable ties and was kept up right by a small buoy attached to the top of the board.



Figure 3H – Test Dive Trail board on the Needles

On returning to the site in 2001 to investigate the effectiveness of the trial marker station it was found that the board and attached buoy had gone. However, the concrete sinker was still in place. This demonstrated that the materials used were not up to the task of anchoring the stations even in the more sheltered areas of the site.

A more appropriate solution

Taking on board experience in previous seasons a review of the methods resulted in a more appropriate solution for this environment. The idea of having information on boards underwater was disregarded, instead a system of under water booklets carried by divers was chosen. It was also realised that the diver trail stations would have to be removed at the end of each diving season in order to prevent them from being ravaged by winter storms.

The new Dive Trail stations would consist of a buoy marked with the station number. These are small durable buoys which are readily available from most chandlers, they are relatively inexpensive and hence can be replaced if lost. The buoys are either fixed to a concrete sinker or are fixed to a separate base station made of a pair of 10kg weights. The buoys are attached to lengths of marine grade chain with stainless steel shackles.

Due to unfavourable weather conditions in 2004 it was not possible to install all of the dive trail stations. However a number were put in place to test the system of installation and to allow the proposed diver trail route to be assessed.

3.1.4 Designing & trailing booklets

The route for the trail on the Needles has been dictated by a combination of the natural geology and archaeological features. A series of six numbered stations have been laid at positions around the trail where there are features or artefacts of interest. The position of the line and the markers does not take divers over the areas of the site where there may be vulnerable artefacts.

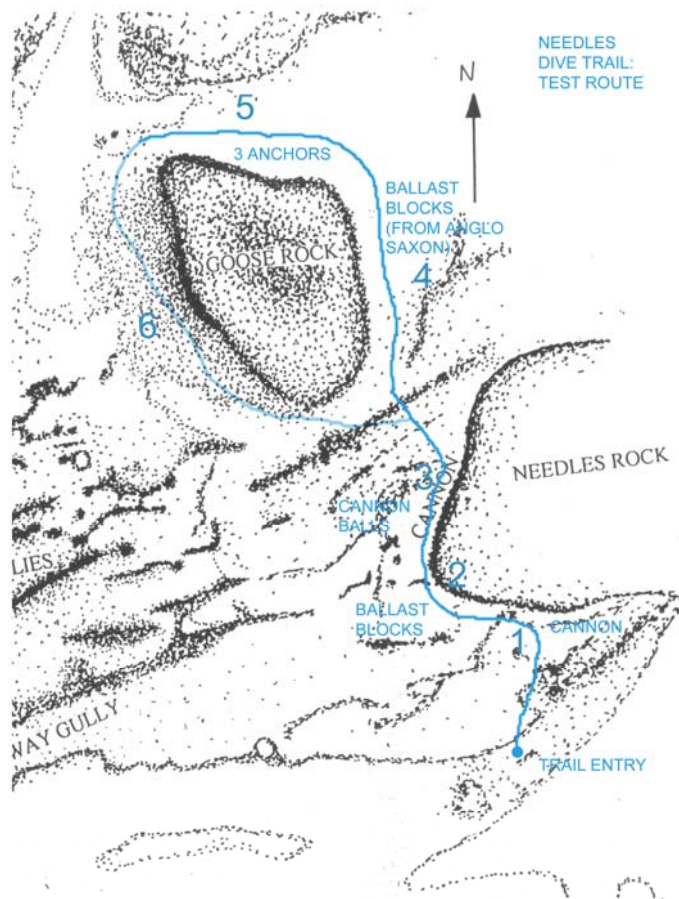

Figure 31 - Trail stations in relation to the Needles site

The trail and the prototype booklets were trialed by volunteer divers during the 2004 season. Although all the trail stations were not in place it was interesting to note that divers were still able to work out where they were and navigate around the site effectively. The volunteer divers were questioned about their experience on the site, the trail line and the underwater booklet.

Each of the Dive Trail stations has been placed to draw attention to particular aspects of the site. At each station the diver is encouraged to view certain artefacts and features. As there is a limited amount of space available for text and images on each page the information has been carefully considered for each of the stations.

Station One – Cannon

One of the first dominant archaeological features encountered on the trail is a cannon lying in an east - west aligned gully directly south of Needles Rock. This is a type of cannon which was used as part of the heavy armoury of the *Pomone*. Information given in the booklet at this station highlights the concretion on the cannon and mentions that inside of the concretion the

artefact will usually look very different. Included with the text is a line drawing of a similar cannon with the concretion removed.

Station Two – Ballast Blocks

At station two the large and regular ballast blocks from *Pomone* are visible. These were necessary to give the vessel stability. The booklet presents a brief explanation of what ballast blocks were required for onboard and briefly mentions the standardisation of cast iron ballast. Images show an example of one of the ballast blocks after concretion has been removed.

Station Three – Cannon balls and shot

One of the most numerous artefact classes to be found on the Needles site is shot of various types. From this station iron cannon shot can be viewed in the base of a gully. The booklet describes different types of shot and briefly outlines the concept of different weights of shot for different sized cannon. These cannon balls lie adjacent to two carronades: short muzzled cannon that were used for fighting at close quarters.

Station Four – *Anglo-Saxon*

The ballast blocks from the *Anglo Saxon*, wrecked 1879 in a force eight gale while transporting a cargo of granite from Guernsey to London are the subject of station four. These ballast blocks can be compared to those from the *Pomone* which were seen at station two.

Station Five – Anchors

The largest surviving artefacts and some of the most impressive for visiting divers are the anchors believed to be from the *Pomone*. They rise up from the seabed and provide a dramatic station stop. The booklet includes a short explanation of why a ship the size of *Pomone* needs these anchors and where on the ship they may once have been stowed.

Station Six – Marine Life and Geology

Although there is an impressive array of archaeological artefacts to be viewed on the Needles dive trail there is also a large range of marine life which inhabits the clay gullies. This station points out a few species of marine creatures, in particular the congas that often make their homes in the crevices formed by the chalk. It is at this point that attention is drawn to the marine geology, the divers having already witnessed the dramatic environment of the chalk gullies and the effects this has had on the shipwreck remains.

3.2 Alum Bay

The Alum Bay I wreck site has been used for a considerable period of time as a site for training volunteers and students in maritime archaeological techniques. To aid diver navigation and to create a framework in which divers can stay within the area of wreckage, a 'guide line' was placed around the extremes of the site. This was held in place by hooked iron pins and weights formed of chain links.



Figure 3J - Diver planning the Alum Bay I wreck

Description of the project

The concept of laying a Dive Trail in Alum Bay was first explored in 2002 during the SolMAP project. It was at this time that the Alum Bay II wreck had just been discovered and work began to map the two wrecks in relation to each other. This initiated the preliminary investigations of a possible area to be covered by a dive trail.

During the 2003 and 2004 seasons, as part of the Leader+, LHI and EH funded project further diving was undertaken to establish and test a dive trail route and booklet.

3.2.1 Site Characteristics

Environmental conditions

Lying to the north and west of the Needles, Alum Bay provides a contrasting diving environment from that on the Needles. The embayment, most famous for its coloured sands which line the shore, is a sheltered area of water which is little affected by tide.



Figure 3K - Divers onboard in Alum Bay

The bay is sheltered from the prevailing south-westerly winds, this means the waters are usually calm although deep swells from the English Channel can disturb seabed sediments. If the wind is coming from the northwest conditions in the bay can become choppy which can make dive preparation uncomfortable and affect visibility if the seabed sediments become disturbed.

The bay is considered a safe dive for all levels of qualifications; local dive schools often use the area for training novice divers. The relatively fine sandy silt seabed means that divers have to take care not to disturb the sediments. Over zealous finning action can quickly reduce the visibility.

Alum Bay is utilised for a variety of boating activities. Pleasure craft often moor in the sheltered bay. The anchors of these boats are the main threat to the wreck sites; some anchor damage has been recorded on the sites. The bay is also used by jet skis, particularly in the summer season.

Fishing activity in the bay is primarily crab and lobster potting. Fishing vessels lay pot lines along the area of reef to the north of the wreck sites. A number of small boats also use the bay for rod fishing.

Seabed and Geology

Running the length of Alum Bay is a rocky reef, the height and extent of the rock outcrops vary along its length. In places the reef forms pinnacles which are a hazard to shipping at low tide; in other places the reef resembles a scattering of rocks. Both the Alum Bay I and II wreck sites lie to the south of this reef.

Around the wreck sites the seabed consists of sandy silt which overlies the underlying bedrock. Both of the wrecks have come to rest in areas where there has been a small dip in the underlying rock. The seabed sediments have surrounded or covered the wooden structure.

There is limited movement of sediment levels across the bay between seasons and this is often quite localised. The sediments around the Alum Bay I wreck have remained at a stable level for over a decade. The Alum Bay II wreck does not protrude as much from the seabed, the amount of structure visible can be affected by more minor changes in sediment levels.

The Wrecks

Section 1.3 outlines the archaeological work undertaken within Alum Bay and the current state of knowledge in relation to the two wreck sites. This section highlights the nature of the archaeological material that is currently exposed on the seabed and will be seen by dive trail participants.

Alum Bay I - This section of wreckage consists of timber hull structure lying with the inside face upwards. The internal fixtures and fittings of the vessel are visible above the seabed. The timber elements consist of wooden frames on an east-west alignment which run the length of the site. Towards the bow of the vessel there is a highly visible section of laminated wooden elements, within which are the lead hawse holes. The iron fittings are related to the iron

brackets which acted as knees by supporting the decks. Copper fastening pins are visible at a variety of locations, although they are most prominent towards the bow. There are no small finds or loose artefacts visible on site. As the wreckage is part of the *Pomone* which broke up on the Needles, it appears that all loose artefacts that were once onboard, were lost on or close to the Needles.



Figure 3L - Alum Bay I wreck site

Alum Bay II - The identity of this smaller wreck is, as yet, unknown. It appears to be the remains of a well-made carvel built vessel. The exposed wooden structure enables us to see external hull elements, particularly carvel planking, treenail fastenings, the keel, internal frames (where the outer hull planks are missing) and limber holes.

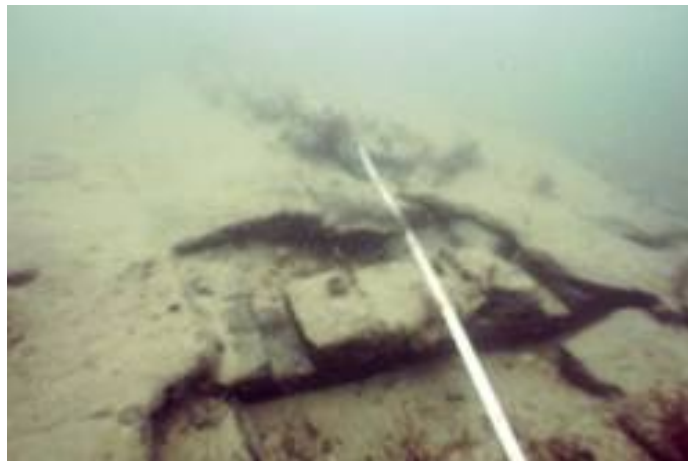

Figure 3M - Alum Bay II wreck site

Passage between wrecks - The trail route runs along the south edge of the reef. Along this route it is possible to see a few stray artefacts. The most numerous of finds are small pieces of what appears to be copper sheathing.

Marine Life and Habitats

The wrecks, seabed sediments and rocky reef create a variety of habitats in which marine life can thrive. The shallow depth of around 7m enables enough sunlight to sustain a broad range of fora on the reef and wreck. These include

mixed red seaweeds and patches of encrusting pink algae. Most other hard surfaces are dominated by animal species. These often look like plants but are in fact colonies of tiny creatures such as hydroids (related to corals) and bryozoans ('moss animals'). Many other species tend to feed on these colonies, so it is here you can see varieties of sea slug. Sponges, seasquirts, fan worms, topshells and the occasional oyster can also be seen.

Across the site larger marine life such as crabs and fish are often visible while the sand supports anemones, tubeworms and slipper limpets.

Alum Bay is included in the South Wight Marine Special Area of Conservation. See section 3.1.1 for further details of this designation.

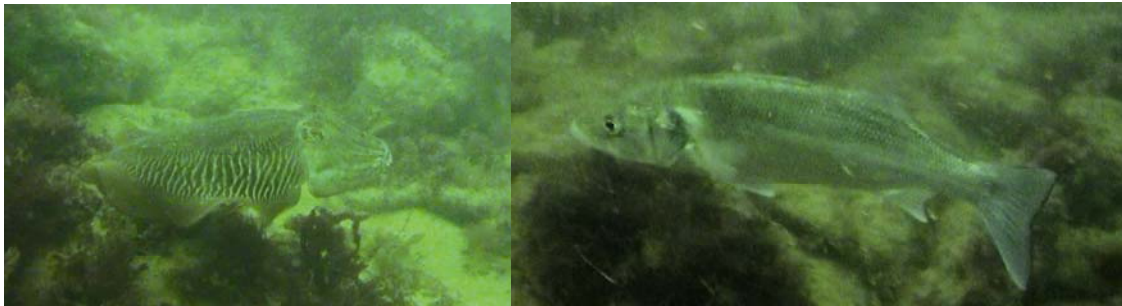

Figure 3N – Marine life found on the Alum Bay Dive Trail

3.2.2 Deploying the trail

Alum bay, unlike the Needles is not protected under the Protection of Wrecks Act 1973. Therefore, access to the site by divers, mooring of boats and the laying of lobster pots over the area is not restricted. These constant threats from snagging and interference restricted the ability to lay a continuous fixed line for divers to follow. Instead a system of independent stations has been developed.

Another logistical challenge for creation of the Alum Bay dive trail was the distance covered. There is a sixty metre distance between the wrecks, so a series of markers have been laid along the southern edge of the reef between the two sites.

3.2.3 Testing marker stations

As the independent station markers are a vital constituent of the Alum Bay dive trail a number of different types of marker station have been trialled. These have been assessed for their visibility, ability to stay in position and the rate at which they accumulate marine growth.

Between 2002 and 2004 the following types of stations were deployed and trialed:

- Bucket station - plastic buckets with a hole in the bottom through which an iron hook protrudes and filled with concrete. These stations proved to be effective underwater. However, they protrude a long way from the seabed,

and were cumbersome when handling on the surface and positioning underwater. Once in position these markers have not moved.

- Uni-strut station - Base is constructed of inter-locked uni-strut channel. These stations were easy to deploy and manoeuvre, however, their relative lack of weight meant they were vulnerable swell and being knocked by divers.
- Weight station - These are the dive trail stations of choice. Formed from a pair of 10kg weight lifting weights held together by rope or chain which also attaches the numbered buoy. As base stations they have a low relief and are sufficiently heavy to ensure that they do not move from position. Over time the weights have settled slightly into the seabed sediment so in places it appears that the dive trail stations rise enigmatically from the seabed.
- Mini-markers - In order to make the sixty metre swim along the reef between the wrecks easy to navigate these markers were produced. They are formed of a foam fishing net float which has been sprayed flourescent yellow. They are weighted with old chain links. These markers proved very effective for keeping on track, however, they had to be closely spaced to account for poor visibility.

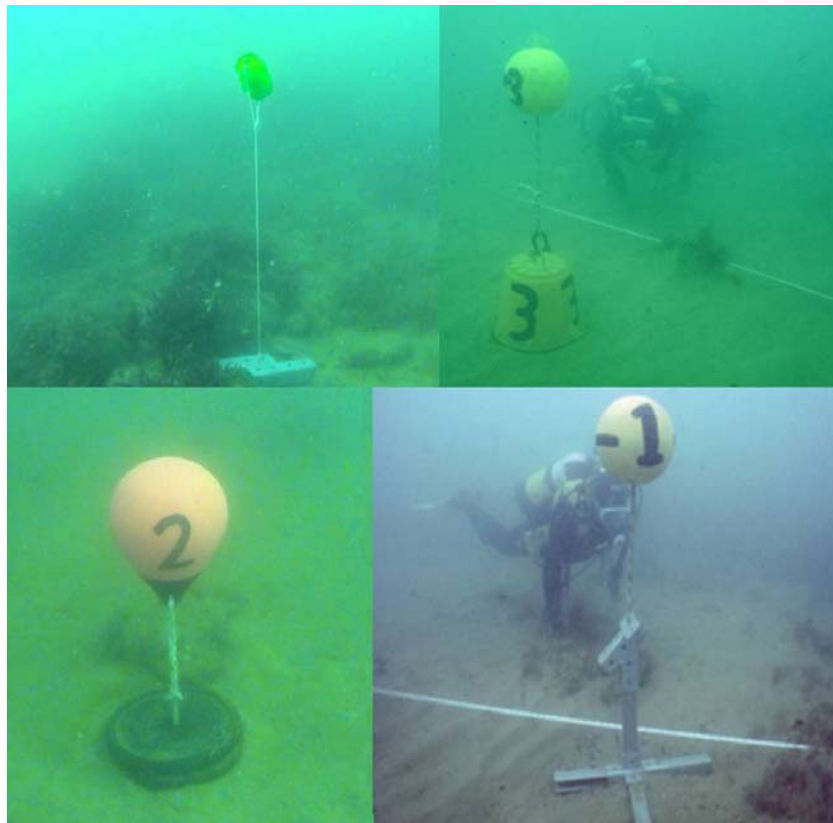

Figure 30 - The four types of trail marker trialled in Alum Bay

3.2.4 Designing & trailing booklets

The Dive Trail route was designed to take in both wreck sites, the reef and associated marine life. Eleven numbered stations were used for the trail. The route was planned to be easy to follow and a trail booklet was produced for testing.

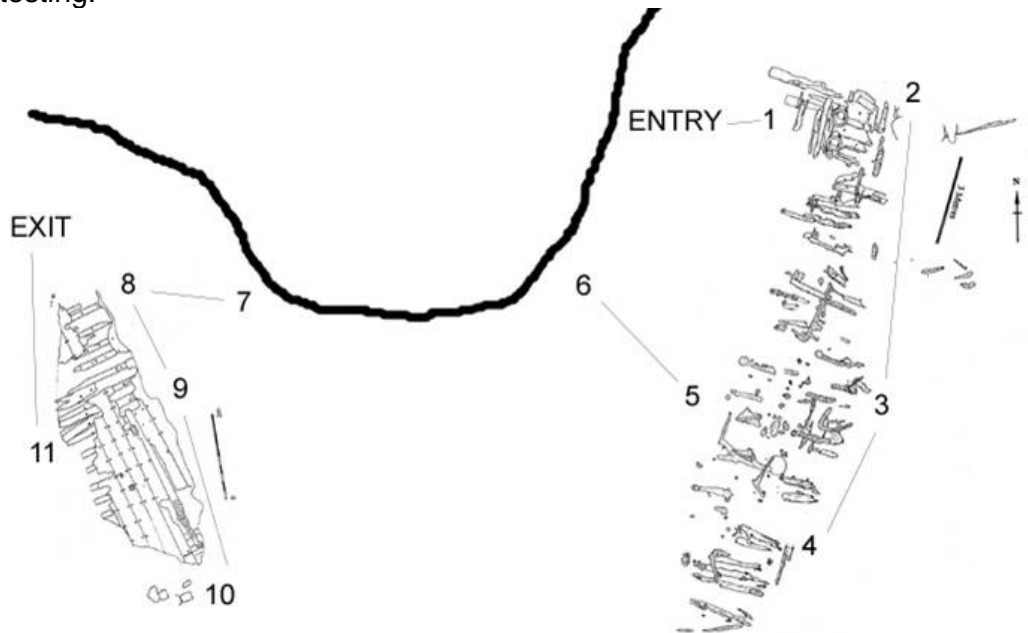

Figure 3P - Initial Alum Bay Dive Trail route

A summary of the Dive Trail stations has been outlined below, however, more detail is given about the subjects covered at each station in section 3.2.5.

- Station 1 - Alum Bay I wreck - hawse holes
- Station 2 - Alum Bay I wreck - timber structure
- Station 3 - Alum Bay I wreck - iron knees
- Station 4 - Alum Bay I wreck - structure & excavation
- Station 5 - Alum Bay I wreck - marine life
- Station 6 - Reef geology
- Station 7 - Reef marine life
- Station 8 - Alum Bay II wreck - Introduction
- Station 9 - Alum Bay II wreck - Hull structure
- Station 10 - Alum Bay II wreck - South end and seabed
- Station 11 - Alum Bay II wreck - tree nails and structure

This trail was laid and a number of volunteer divers were used to test the trail. The 'test' group included divers who were familiar with the wreck sites and those who had not visited previously.

A questionnaire was developed to gauge the reaction of the test group (see appendix E.4 for a copy of the evaluation questionnaire). The general reactions to the Dive Trail were very positive, however, a number of issues were raised. Some of the main concerns related to:

- The route of the trail in relation to the trail stations - due to the trail route going down one side of the site and returning back up the other side on both of the wreck sites there was a tendency for divers to reach the wrong trail station first. This meant there was some slight confusion over where on the trail they should go next.
- Booklet pages were difficult to turn - the trial Dive Trail booklets were made of laminated sheets and divers wearing gloves found the pages difficult to turn. This issue will be addressed in the finalised booklet which will have thicker pages.
- Starting on the most dramatic wreck - several participants mentioned that the trail starts on Alum Bay I wreck where there is a lot of different structure to see. Excited about the rest of the trail they headed fairly quickly on along the reef to Alum Bay II. As there is less to see at the Alum Bay II site they mentioned that the end of the trail was a bit flat compared to the start.
- Staying on track - there is a considerable distance between the wreck sites, although there are a number of 'mini-markers' guiding the way in poor visibility some of the divers found these quite difficult to follow for long periods.

3.2.5 Re-deploying the trail

In order to address the feedback from the Dive Trail testers a decision was made to re-deploy the trail. This would allow problems with reaching the trail stations in the wrong order to be addressed as the trail is now more linear.

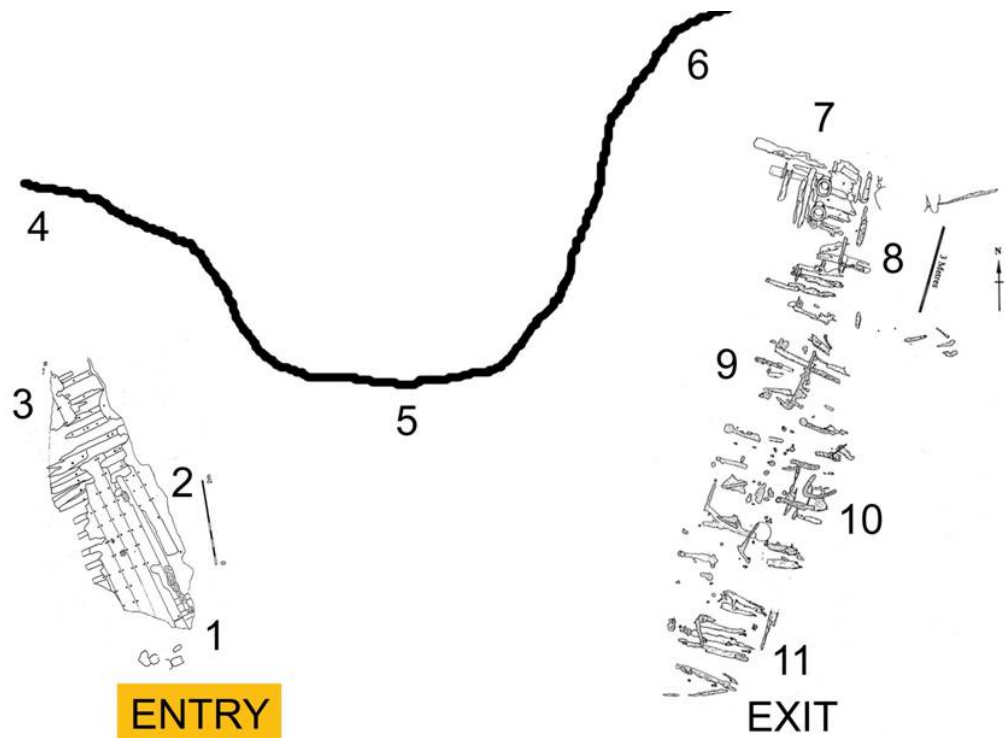

Figure 3Q - The final Alum Bay Dive Trail route

The dive trail stations are now set out as follows:

Station 1 - Alum Bay II wreck

The trail begins with introducing the Alum Bay II wreck. The booklet contains information on the marine life that can be seen close to the wreck, which included anemones.

Station 2 - Hull structure

The carvel built outer hull structure is introduced; the treenail fastenings between the planking and the frames are highlighted. Attention is drawn to an area where the hull planking is missing and it is possible to see the internal frames. Images included at this station show a close up of the timber structure.

Station 3 - AB II wreck

The final station on this wreck is at the north of the site. Information highlighted here includes an explanation that the date and identity of the wreck is currently unknown. The edge of the visible wreck site, where the structure slips under the seabed sediment is pointed out to raise the issue of how much more structure lies buried.

Station 4 - Hazardous Shores

This is the first station along the reef. Text here highlights the danger to shipping that reefs present and the large number of wrecking incidents around the shores of the Wight.

Station 5 - Reef marine life

This page aims to highlight the abundance of marine life that can be seen along the reef. Just a few of the species present on site include: sea slugs, hydroids, bryozoans, sponges, fan worms, oysters, crabs and fish. There is a picture of a sea slug to accompany the text. These particular sea slug are apparently rare around the coast of Britain, dive trail participants will be encouraged to report any sightings of them.

Station 6 - Geology of the reef

The geology of the reef is briefly presented; this includes an explanation of the type of stone that makes up the reef. The geological processes reflected in the cliff of Alum Bay are world famous. The irregular strata continue underwater providing topographical and material variations on the seabed.

Station 7 - Hawse holes

This is the first station on the Alum Bay I wreck site. One of the most prominent features of the site is presented here. The hawse holes are illustrated and their use for the anchor chains is explained.

Station 8 - Timber structure

Still at the bow end of the wreck site the layers of timber present around the hawse holes is highlighted. The reason why this part of the ship requires so much reinforcing is briefly explained.

Station 9 - Iron knees

The most upstanding structure on the wreck site is the only remaining intact iron knee, all the others have been broken off and are visible as horizontal 'strips' of iron. An explanation that the iron knees once supported the ships deck is given and it is pointed out that you can see two rows of iron knees on the structure.

Station 10 - Wreck marine life

This station highlights the physical conditions around the wreck site and the diversity of marine life that can be found here. Information is given on the nature of the seabed sediments and the habitats these provide. Species to be seen on the wreck include mixed red seaweed, encrusting pink algae, hydroids, sea squirts and crabs.

Station 11 - Structure and excavation

Excavations on site have exposed the southern end of the site; some of the results of this work are presented here. The role of the plastic numbered tags that can be found on the wreck are explained along with detail of the buried structure.

See appendix 8.3 for an example page of the underwater booklet.

An extra guide

To improve the marking of the route between the wreck sites further mini markers were added to the trail. In addition a length of blue plastic covered steel cable was fixed along a section of the reef. In poor visibility this will act as an extra guide to divers who should pass to the south of this line.

4. Logistical and running considerations

While the design and establishment of the Dive Trails on site has taken considerable time and effort, the work has not stopped there. The logistical and administrative aspects of the operation of trail have involved the full design of the Dive Trail experience and all associated research and materials.

4.1 Research and production of underwater booklets

The production of the underwater dive trail booklets has not been a straightforward task. Research has discovered that there are very few printers or paper manufacturers that can produce suitable materials. Our initial specifications for an ideal underwater booklet has had to be modified due to the impossibility of production at a cost that is feasible.

Viable options for production

Encapsulated printed pages with plastic binding - this option is the most cost effective for the production of multiple copies of the underwater booklets. Lithographic printing onto a thick paper allows for full colour booklets, this is then encapsulated leaving a margin around the pages to prevent water entering the booklets. Binding uses a sturdy plastic spiral.

Printing onto poly art - this paper allows for direct colour lithographic printing onto thick, plastic impregnated paper pages. This is an established way of producing underwater materials, however, the polyart paper is not very thick which presents a problem when turning the pages in water with dive gloves.

Printing onto plastic board - it is possible to print onto flexible plastic board; a number of 'fish identification guides' use this type of materials. This material is best using two tone printing as it will not take full colour print. Due to the high cost of this material it was not possible to use it for the underwater booklets.

We have contacted a variety of printers and publishers concerning the production of the underwater booklets. We have been dealing with two companies in particular:

Aquapress (www.aquapress.co.uk) - they specialise in maritime books and guides and have been particularly helpful in providing possible solutions to our printing requirements. They are able to produce booklets using any of the above options.

Studio 6 (www.studio-6.co.uk) - are a printing company who have investigated possible options for encapsulation.

4.2 The dive trail package

The project aims to deliver the Dive Trail experience to as wide an audience as possible enabling not only divers to enjoy the submerged heritage, but also interested non-divers. The package involves a multi media presentation outlining the history of the sites, a visit to Fort Victoria Maritime Heritage Exhibition and a pre-dive briefing. Non-divers will have a boat trip from Yarmouth around the Alum Bay and Needles sites, while divers will head out to the site to dive the trail/s. Some divers or dive clubs will be able to utilise their own boats and other divers will require the use of a charter boat. The

range of possible logistical arrangements has enabled us to offer three principle Dive Trail packages.

- **Dive with your club**

This is the simplest option in terms of logistics and administration. A dive club will contact us to arrange a date for their participation in the Dive Trail and the package will be arranged. They will organise either their own boat or a charter boat and their own travel to the Isle of Wight. A non-returnable deposit will be paid to cover costs in the event of non-attendance.

- **Dive with us as an individual or small group**

This package will be available on selected dates throughout the summer season for individuals or small groups. The HWTMA will arrange a charter dive boat from a local destination which people can book onto in conjunction with their Dive Trail booking. This package requires more administration time than the 'Dive with your club' option. Set dates for this package will be advertised as it will be necessary to get enough participants booked to fill the charter boat. The number of dates for this package during a season can be adjusted depending on demand.

- **Non-diver trail**

Non-diver participation in the Dive Trail experience is possible and will be encouraged. Non-divers can participate in the pre-dive lecture and learn about the site, the history of the wreck etc. Depending on levels of interest the non-diver trail can operate on the same day as a diver trail, this may appeal to divers partners and children. Or, the non-diver trail can operate on separate days. The number of non-diver trail days can be tabled dependant on demand.

4.3 The diver trail experience

The Dive Trail experience is designed to last a whole day, it will consist of the following components:

- **Pre-package information** - When enquiring and booking the trail a pack of information will be posted or emailed out. This will include leaflets detailing the itinerary for the dive trail, local facilities and accommodation.
- **Presentation** - the presentation will be given at Fort Victoria in the lecture room, or if required in the meeting room at the Yarmouth Harbour Masters office. This will include details of the history and fate of HMS *Pomone*, the excavation of the wreck, discovery of the Alum Bay sites and information on the dive trail itself.
- **Package literature** - Participants will receive a copy of 'A Year in Depth' the HWTMA's annual report and a copy of 'The Story Beneath the Solent' to inform them of the area's fascinating maritime heritage.
- **Visit to Fort Victoria Maritime Heritage Exhibition** - It is beneficial for people to understand the richness and importance of the maritime heritage in the area and learn from it, so promoting interest and enthusiasm for protection of the maritime heritage.

- **Dive briefing** - The dive brief is important, it will ensure that divers are acquainted with the type of conditions to expect, and safe diving can be undertaken with minimal risk.
- **The Dive** - Divers will be loaned an underwater Dive Trail booklet (for which they must pay a deposit) and go in either their own boat, or a boat chartered by HWTMA, and dive the trail. This enables diving to take place in a controlled manner, the dive being enhanced by knowledge of the wreck through the underwater guide booklet.
- **Boat trip** - Non-divers will take a boat trip on a charter boat that operates from Yarmouth to visit the area and view the spectacular scenery of the Needles wreck site and the beauty of Alum Bay's coloured towering cliffs. There may be an option for families of those diving to visit the site on the boat along with the divers if space allows.

Presentation and briefing details

The presentation for all Dive Trail participants aims to introduce the history of the Needles and Alum Bay sites and more general information on maritime archaeology. It consists of the following subject areas:

Maritime archaeology of the Solent

Introduction to the submerged cultural heritage of the region, this will include information on the variety of types of sites that can be found underwater. A variety of images will be used to illustrate the diversity and distribution of these sites.

History of HMS *Pomone*

Participants will learn of the history of the *Pomone*, what type of ship it was, and of the purpose of the historic voyage. This will enable people to understand the significance of the role the vessel played in history.

The wrecking on the Needles

An account of the wrecking will be portrayed, this will include information on the fate of the ship and crew immediately after the event. This very human aspect of the story adds another dimension to the site.

The excavation

An outline of the excavation and survey, will include images and details of artefacts discovered. This is very important because of the significance of what was learned from the wreckage and the trapped wreck material. Details of how survey and archaeological data has been used to help understand the wrecking process of the ship and its ongoing relationship with the physical environment will be presented.

Alum Bay site

The history of the discovery of the wreckage in Alum Bay and the subsequent survey to establish that it was part of the *Pomone* will be explained. This will add interest to the dive allowing divers to search out the diagnostic features that help place the vessel in a particular time frame. Non-divers will also be intrigued by what can be learned by this detective work.

Setting up of the Dive Trails

An explanation of how and why the Dive Trails were set up. The reasons behind the scheme and the importance of giving people from all walks of life access to this kind of resource which would otherwise be out of bounds to many.

Dive Briefing

All divers will receive a dive brief, which will explain the lay out of the trail, depths and conditions to expect at the dive site. Participants will be reminded how they should conduct themselves when diving an historic wreck site, this will be reinforced by providing a laminated copy of the Dive Trail Code of Conduct (section 4.3) to each participant. Divers will be briefed on entry and exit to the sites, and on any additional necessary precautions, particularly when diving the Needles wreck site. Other information will be included such as the use of a surface marker buoy throughout the dive.

Visit to Fort Victoria Maritime Heritage Exhibition

The Maritime Heritage Exhibition at Fort Victoria is a key feature of the Dive Trail experience. The Exhibit will usually be visited before diving the trail, this will enable participants to gain a deeper insight into maritime heritage.



Figure 4A Entrance to the Fort Victoria Maritime Heritage Exhibition

At the exhibition there are display panels directly related to the Needles Protected wreck Site, these include the story of *Pomone* wrecking and archaeology on site. There is also a multi media presentation including a cartoon representation of the wrecking and discovery and video footage from the site.

In addition to the information relating specifically to the wreck sites participants will view displays relating to 'What is maritime archaeology', the importance of the submerged cultural resource, the Protected Wreck sites of the Solent, the submerged prehistoric landscapes of the Solent, Marine artefacts and conservation and the history of the Fort (to name but a few).



Figure 4B Example displays at the Maritime Heritage Exhibition

The Alum Bay dive

The Alum Bay site can be dived at most states of the tide so time is not critical. Divers will travel on their own boat (or chartered boat) from Yarmouth to Alum Bay where they will conduct the dive with the aid of the underwater booklet, giving information on the features at each station. They will descend to the wreck via a fixed buoyed shot line to the trail, at Alum Bay II and travel around the guided trail, across the reef, to Alum Bay I where they can ascend. Here their boat can then pick them up.

Divers using their own boat will be required to return to Yarmouth to retrieve the deposit for their underwater booklets.

The Needles dive

The Needles Dive Trail will be offered to advanced divers. It is envisaged that this dive trail will be less frequently used due to the un-predictability of the weather.

Divers will enter the trail to the south of the site via a fixed buoy, this will lead them to the start of the trail. They will use the Needles Dive Trail underwater booklet on their journey around the fixed trail. The line on the Needles site loops back on itself, this is necessary to ensure that divers can exit the same way as they entered the water; the buoy is positioned in the safest area for recovery and entry.

The divers using their own boat will be required to return to Yarmouth to retrieve the deposit for their underwater booklets.

Non-diver boat trip

Following the presentation and visit to the Maritime Heritage Exhibition non-divers will take a boat trip on a local pleasure craft to view the Needles and Alum Bay wreck site areas. The purpose of broadening the appeal of the Dive Trail to the wider public is to provide access for all to this resource. If non-divers can access this aspect of their heritage it will promote more interest in protecting it.

The diver trail 'Code of Conduct'

In order to ensure all divers are aware of any potential issues regarding the sustainable diving of historic wreck sites they will be issued with a Dive Trail Code of Conduct. This simple eight point code reinforces the messages given during the presentation and visit to the exhibition. The Code will be produced as small laminated cards that can be taken on the boat as a reminder.

Follow the Dive Trail Code of Conduct

Safe Diving!

- Always follow safe diving practices
- Follow the designated trail
- Be buoyancy aware - you could be stirring up silt or damaging the wreck

Maritime Heritage

- Treat all cultural heritage with respect
- Do not be tempted to move or pick up artefacts
- Do report the sighting of any artefacts not highlighted in the booklet to the Dive Trail Co-ordinator
- Never buy or sell items from historic wreck sites, encouraging such trade creates a market

Marine Life

- Do not harm any marine life encountered on the trail

4.4 Logistical considerations

4.4.1 Diver ability and experience

All divers will be asked to provide evidence of training and experience, those who do not demonstrate adequate experience will be refused booking. In the event of this decision being queried there will be an option for potential participants to provide two references who can verify the divers experience. This is relevant to both the Alum Bay site and the Needles site, although as the Alum Bay trail is in shallow, calm water it should be suitable for all but novice divers.

The Needles Dive Trail will only be offered to divers holding advanced qualifications, their names will need to be added to the Visitors Licence for this Protected Wreck Site.

Boat availability

There are very few diving charter boats that operate from the Isle of Wight, however, there are a range available from the mainland. Many of these boats regularly take divers to wrecks around the Island. The closest available boats for the Dive Trail are hard boats and RIBS that can be chartered from Lyminster. These boats can pick up divers from Yarmouth. There is also a RIB available for charter from Cowes.

The popular dive charter boats are often booked up from very early in the dive season (if not from the year before). In order to use these boats to run dive

trails, particularly on weekend dates forward planning if required. There is usually more flexibility for boat availability on week days during the season.

Tides and weather conditions

The environmental conditions experienced on each of the Dive Trail sites have been outlined in sections 3.1.1 and 3.2.1. The tides and weather conditions will be monitored prior to any diving activity. Dive Trail dates on the Needles site will be booked to take advantage of neap tides, this trail will only be able to operate in optimum weather conditions. Alum Bay is usually less weather dependant, unless the wind is blowing from the North or North West.

A cancellation procedure has been put in place to account for situations when the weather prevents diving activity on the sites.

Transport between Yarmouth and Fort Victoria

For divers and non-divers participating in the trail there is a need to get between Yarmouth and Fort Victoria. There are a number of possible options for travel:

- On foot - the coastal footpath runs along the water front and makes a lovely walk, it is just over half a mile between the sites.
- By car - for those who have taken their car to the Island Fort Victoria is well sign posted.
- By bus - a regular bus service operates from Yarmouth to Fort Victoria during the summer season.

4.5 Administrative considerations

Booking and administration

In an effort to minimise the administration time required for Dive Trail bookings a comprehensive Dive Trail information pack has been developed for participants. These packs are sent to all individuals booking on the Dive Trails and include information on:

- Conditions of Booking and Cancellation
- Forms - disclaimer
- Travel and transport options (ferry timetables/ bus timetables)
- Accommodation
- Dive boat charter
- Safety at Sea
- Promotional CD
- Places to visit on the Isle of Wight
- Details of the local nature designations

To streamline the booking process a dedicated email address has been created for all Dive Trail enquiries (diving@hwtma.org.uk). Whenever possible a single member of staff will be responsible for dealing with Dive Trail administration.

Cancellation procedures

All participants on any of the Dive Trail packages will be required to pay a non-returnable deposit in case of cancellation. The 'conditions of booking' on the Dive Trail have been outlined and will be included in the Dive Trail information pack that each participant will receive.

In instances where cancellation is necessary due to bad weather an alternative date or activity will be set where possible, otherwise a refund will be offered.

Staffing for Trail days

Demands on staff resources will be similar across each of the packages, the only package which may require additional staff time is the 'Dive with us' option. A member of staff may accompany divers on the charter boat while they dive the trail, they will then be able to collect the underwater booklets from participants and return their deposits.

Staff time requirements for Trail days:

Presentation and venue preparation	1 hour
Giving presentation and dive briefing	1 hour
Introduction to display and being on hand to answer questions	1.5 hours
Meet dive boat in Yarmouth to collect booklets	0.5 hours

Monitoring quality

To assess the Dive Trail each participant will be asked to fill in a 'Dive Trail Assessment' Questionnaire. This will enable us to gauge the reaction of those taking part. This questionnaire will encourage feed back on all elements of the Trail experience including:

- The pre-trail information
- The presentation
- The Maritime Heritage Exhibition
- The dive experience – boat and underwater booklet
- The boat trip (non-diver trail)
- The general learning experience
- Value for money
- Any improvements that could be made

The HWTMA will monitor the questionnaires in order to respond to any frequently mentioned aspects of the Dive Trail that may need improvement or adaptation.

4.6 Trail maintenance considerations

General trail maintenance

As the seabed environment can be dynamic it is necessary to plan for general trail maintenance that may be required. To pre-empt possible problems the following spare items have been purchased: Trail station marker buoys, station weights, chain for markers, plastic covered cable.

With these items in stock we are able to respond quickly to any instances where there has been damage or disruption to the trails.

Alum Bay maintenance

The dive trail will be periodically inspected by HWTMA staff to check that all the station markers are in place and the mooring buoy is not moved or corroded. If a problem with the trail is reported by a dive trail participant then immediate action will be taken to restore the trail. The principle activity on the Alum Bay seabed is from anchors, the trail has been designed to minimise the possible damage from anchors.

The trail will be lifted at the end of each diving season. Each trail station will be dismantled for seasonal maintenance, this includes removal of any marine life from buoys and repainting the numbers if necessary, wire brushing the base stations and repainting to reduce corrosion, the replacement of any chain that has become corroded or worn.

Needles maintenance

The maintenance requirements for the Needles site will be similar to that on Alum Bay. Due to the dynamic nature of the site the materials used here are more robust than those on Alum Bay. There will be a requirement to check that the trail line is in place and is not obscured or buried. The plastic covered steel cable usually benefits from a clean with a scouring pad to remove any marine growth.

The trail will be lifted at the end of each diving season and any maintenance undertaken.

5. Marketing

An important part of the project has been the development of a marketing strategy and associated publicity materials. Considerable thought and planning has been spent on the most effective ways of marketing the trail. The result has been a range of dynamic materials aimed at catching the attention of divers and non-divers.

Opportunities for marketing the Dive Trials exists through a range of media on a local, national and international scale. The project has taken advantage of any available opportunities that have been possible within the budget.

5.1 Promotional materials

Leaflets

A Dive Trail marketing leaflet has been produced, it aims to provide outline information on the trail in addition to contact details. This marketing tool will be distributed widely within the UK through a variety of outlets and promotional events. 5000 of these full colour A4 size folding leaflets have been produced for distribution.



Figure 5A - Extract from Dive Trail marketing leaflet

Posters and information panels

An information display panel on the Dive Trail has been produced in A1 format, this is displayed in the Maritime Heritage Exhibition at Fort Victoria in addition to our mobile display. This panel gives general information on the trails can be used in conjunction with existing HWTMA panels which present further detail of archaeological work undertaken on the relevant sites.

A3 poster versions of this information panel have also been produced for use in dive shops, attractions etc. This enables a wider distribution of information across a range of audiences.



Figure 5B - Dive Trail promotional poster and panel

CD/DVD

Underwater video footage of the Dive Trail sites is a particularly valuable marketing tool. Extensive video footage and stills have been taken of both sites, this has been utilised for marketing purposes in addition to forming part of the Dive Trail presentation. This footage has also been used at the Dive Show (see section 5.2) and for other formal marketing and presentation situations.

A promotional CD with underwater footage and topside images has also been produced as a marketing tool to accompany promotional literature. This is a highly cost effective way of marketing the Dive Trails.

5.2 Promotional events

Dive shows

There are two large dive shows per year in England, these are based in London in March/April and Birmingham in October/November. These events provide one of the best opportunities to market directly to thousands of divers.

The HWTMA stand at the London Dive Show on 5/6th March 2005 created a lot of interest. The stand highlighted the work of the HWTMA as a whole with a strong emphasis on the launch of the Dive Trails. Information boards and a DVD presentation on the trail were on display and leaflets were distributed. Divers wanting further details of the trail left their name and address, they were then sent a copy of the promotional CD.

Press launch

The Press Launch for the Dive Trails has been planned to take place on the 20th May 2005 (this report has been completed to coincide with the launch, so you may be reading this from your 'Launch CD!'). The launch is designed as a marketing tool, and as an informative day for all those who have helped or been involved with the creation of the Dive Trails.

The launch involves the following:

- A presentation on the Dive Trails at Yarmouth
- A visit to Fort Victoria Maritime Heritage Exhibition
- A dive on the Alum Bay trail for diving participants
- A boat trip around the Alum Bay and Needles sites to coincide with the Divers exiting the water after diving the Alum Bay trail
- A formal launch at Yarmouth Castle

The launch should receive good press coverage and help to raise awareness of the trails locally and nationally, it should also contribute to raising awareness of the submerged maritime heritage of the Solent.

5.3 Advertising opportunities and venues

Display boards in maritime heritage exhibition

For visitors to the Maritime Heritage Exhibition at Fort Victoria there is a chance to find out about the Dive Trails through information on display boards. They can also pick up a leaflet containing details of where to find out more about booking on the trail. The staff on the desk at the MHE can also give interested people further information about the trails.

Visitors to the MHE include tourists from Britain and abroad in addition to local Island residents. Getting information about the trails to local residents is important, many have visitors who they recommend activities to, and many people are involved with wider aspects of the tourist industry.

Partner attractions and exhibitions

The tourism industry in the West Wight region is invariably inter-linked, many attractions and businesses recognise the advantage of working together. A number of other attractions and contacts in the region have agreed to take marketing material on the dive trails.

Diving publications

There are a number of established diving magazines that are available on the high street, these cater for the ever growing sport diving community. A programme of targeted advertising in these magazines will be undertaken through out the season to ensure that the profile of the diver trails is maintained.

Dive shops, centres and schools

A large number of local dive shops, dive centres and schools will be encouraged to display Dive Trail publicity materials. Efforts to link with local businesses will be made to ensure that 'word of mouth' communication about the trails spreads. Local dive schools may be interested in using the Alum Bay

Dive Trail for training exercises such as navigation, the underwater booklets can be used in conjunction with a compass.

In addition large dive shops and schools will be targeted nationally to display advertising materials. Divers regularly travel long distances to dive from the south coast of England, this is an audience that can be targeted.

5.4 Targeted groups

Dive clubs

Local dive clubs will be targeted for advertising, many of these groups may have their own boat which they can use to dive the trail. If appropriate promotional talks will be offered to larger clubs which will highlight the maritime archaeological heritage of the Solent and advertise the trails.

Local community

Many members of the local community have an interest in and knowledge of the wreck sites of the region, they will be targeted for advertising for the non-diver trail. In the first instance we will contact local community groups, particularly those with a historical or maritime focus, dependant on the uptake from these groups this type of advertising will be extended to the wider community as appropriate.

5.5 Internet and email advertising

The growth in electronic communication means that an international audience can be reached relatively easily. The Dive Trail web pages are available to view as part of the HWTMA website:

www.hwtma.org.uk/trails/index.htm

The number of visits to these pages are monitored.

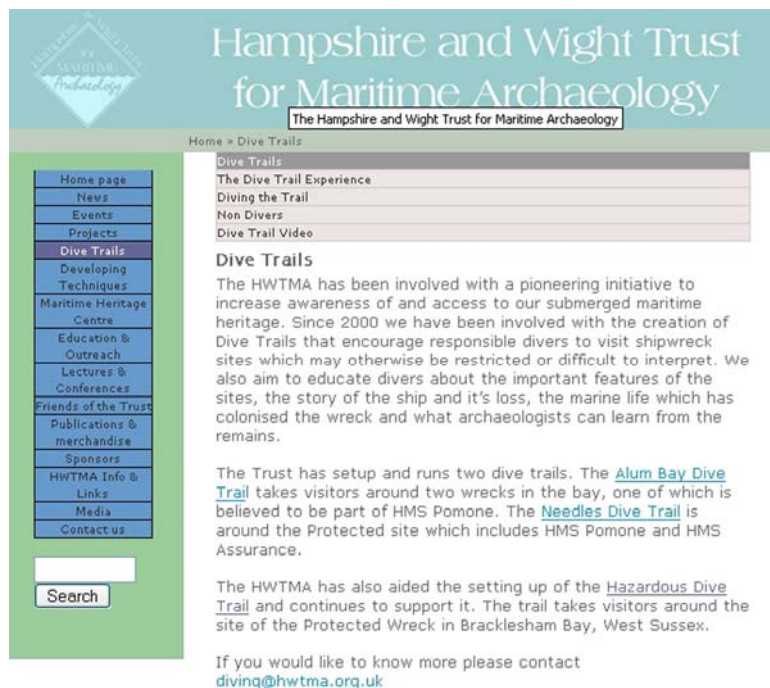

Figure 5C - Dive Trail web pages

The pages contain details of the Alum Bay and Needles Dive Trails in addition to information about the Warship *Hazardous* Dive Trail. There is also video footage available to view online.

The Dive Trail webpages are being used as a marketing tool in addition to being available as a general information resource for anyone who is interested in the project.

The presence of the webpages can be advertised through emails to relevant individuals and organisations. This is a fast and effective way of reaching a large number of individuals.

6. The future for Solent Dive Trails

6.1 Lessons learnt

The response to the Alum Bay and Needles Dive Trail Project has been overwhelmingly positive. Our experiences on these two very different sites, in addition to our experience with the Warship *Hazardous* Dive Trail, has provided a solid foundation on which to build.

The challenges faced through the administrative planning and on site logistics have necessitated a variety of solutions enabling the Dive Trail concept to be applied to the environmentally and archaeologically difficult sites resulting in a high quality product.

In the short term the Dive Trails exist to fulfil a need to provide information on, and access to, historic shipwrecks. The emphasis is on providing participants with a fun and enjoyable experience that also involves the dissemination of information. The Needles Dive Trail also fulfils an important role in providing access to a Protected Wreck Site that would otherwise be off-limits to divers.

In the long term the benefits of the project should be:

- Increasing public awareness of the submerged cultural heritage
- Educating divers in what to look out for on historic wrecks
- Promotion of the sustainable use of the submerged cultural heritage

6.2 Taking the Solent Dive Trails initiative further

We plan to work towards the establishment of a network of Solent Dive Trails. The vast shipwreck resource of the area means there is no shortage of possible wreck sites that could be included in the scheme.

It is envisaged that an adaptable approach to different sites will be required. The levels of detail provided for divers could vary between sites, with some being a simple laminated diver card and others with a more full interpretation as in the Alum Bay and Needles examples.

With a network of Dive Trails established investigation into the feasibility of running longer Historic Wreck Diving weekends or weeks will be considered. In addition to offering dives on some important historic wrecks there is a wealth of maritime museums and displays that could be incorporated into the experience.

6.3 Spreading the word

The results of our experience with Dive Trials is being made available via the internet on our Dive Trail pages:

www.hwtma.org.uk/trails/index.htm

We also intend to use the results of this project as a foundation for an academic publication considering the Solent Dive Trails and their contribution to public understanding and appreciation of the submerged cultural heritage.

7. References

Joint Nature Conservation Committee, 2004, Website:

<http://www.jncc.gov.uk/protectedsites/sacselection/sac.asp?EUCode=UK0030061>

Larn, R. (ed) 'The wreck of the Dutch East Indiaman Campen on the Needles rocks, Isle of Wight, 1627 – Part I. International Journal for Nautical Archaeology Volume 14 No 1 (1-31)

Momber, G. & Geen, M. 2000 '*The application of the Submetrix ISIS 100 Swath Bathymetry system to the management of underwater sites*' in International Journal for Nautical Archaeology Volume 29 No 1

Tomalin, D., Simpson, P. & Bingeman, J. 2000 '*Excavation versus sustainability in situ: a conclusion on 25 years of archaeological investigations at Goose Rock, a designated historic wreck-site at the Needles, Isle of Wight*' in International Journal for Nautical Archaeology Volume 29 No1

8. Appendices

8.1 HWTMA Grants and Donations 2003/4

Hampshire County Council
Isle of Wight Council
Southampton City Council
English Heritage
Crown Estate
English Nature
Isle of Wight Economic Partnership Leader+ Programme
(supported by DEFRA & the European Union)
Hampshire Wildlife Trust & English Nature *(supported through DEFRA's Aggregate Levy Sustainability Fund)*
Local Heritage Initiative administered by The Countryside Agency
(supported by the Heritage Lottery Fund and the Nationwide Building Society)
Wightlink Ltd
Herapath Shenton Trust
Betty Silverwood Lamb
David Guy
British American Tobacco
Daisie Rich Trust
Hilton Cheek Trust
Manifold Trust
The Rachel Charitable Trust
Lady Tidbury
Solent Protection Society
Wartsila UK
Chichester Harbour Conservancy
J R Kelting
Watson Wyatt
Ovalway Hydraulic Engineering
A & P Group
Mitchell Powersystems
CBA Wessex
Ernst & Young
Macfarlanes

8.2 HWTMA Policy Statements

8.2.1 HWTMA Aims and Objectives

Aim:

The Hampshire & Wight Trust for Maritime Archaeology will promote interest, research and knowledge of maritime archaeology and heritage in Great Britain with core activities concentrated in the counties of Hampshire and the Isle of Wight and the adjacent South Coast area.

Key Objectives

The Trust Will:

- Promote maritime archaeological study in accordance with professional and museum codes of conduct and practice.
- Promote the in situ preservation and management of important archaeological sites in its area of interest.
- Support local, regional and national initiatives for improvements to the legislation regarding the preservation and management of the maritime archaeological heritage.
- Promote public awareness, enjoyment and participation in the maritime archaeological heritage.
- Provide a maritime archaeological service to Hampshire County Council, the Isle of Wight Council, Southampton City Council, Portsmouth City Council and other Local Authorities.
- Ensure that the maritime archaeology plays an important role in coastal planning, management and policies in the Solent and Wight areas.
- Carry out maritime archaeological surveys and investigations for incorporation into environmental assessments and similar studies.
- Compile and maintain a database, and base chart, of all known maritime archaeological sites in the Solent and Wight areas and exchange information with local SMR holders and the National Archaeological Record (Maritime Sites).
- Promote archaeological awareness and competence amongst divers.
- Support, and where possible, assist in the publication of the results of maritime archaeological investigations, surveys and research undertaken in the Solent, Wight and adjacent South Coast areas.
- Liase with other local, regional and national organisations involved in maritime archaeology and related disciplines.

8.2.2 Summary of HWTMA Education Policy

Our Core Education Aims are to:

- Promote education and lifelong learning through interest, knowledge and fun.
- Become an Educational Resource for schools and Higher education Facilities.
- Promote public and professional awareness of the HWTMA and the Exhibition at Fort Victoria.
- Provide access to underwater landscapes and archaeological sites for both divers and non-diving visitors.
- Offer work experience and archaeological skills training to interested parties.
- Develop the Friends network and encourage social inclusion.
- Support and involve the Trust in local and national education initiatives and projects.
- Develop new audiences and encourage repeat visitation.

8.3 Extract from Alum Bay underwater booklet



Station Seven Hawse Holes

Here you see the striking ovals of the lead linings of the Hawse Holes. They may have heavy marine growth but are still easy to spot.

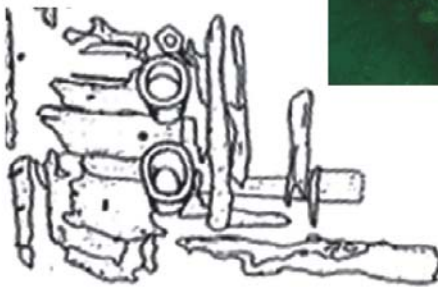
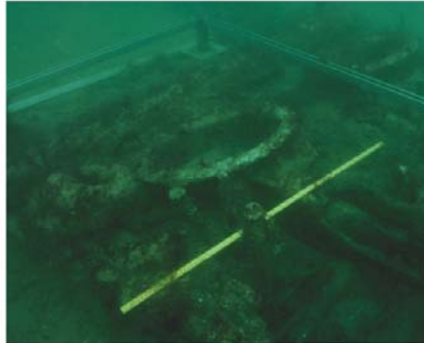

The ships anchor chains passed through these holes as the anchors were raised and lowered.

Move on to the next station

Directions:

Swim **east** then **south** following around the timber structure until you reach station 8.

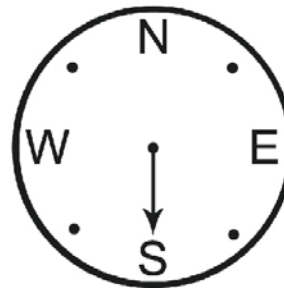
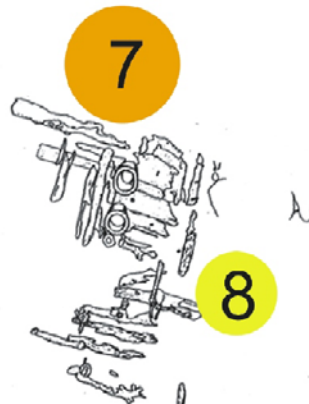
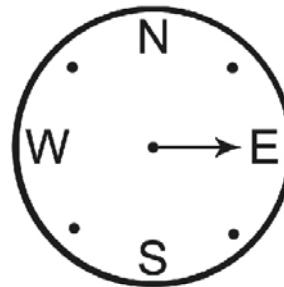

8.4 Dive Trail evaluation questionnaire

Dive trail questionnaire

Phase 1 trials

SECTION 1 – DIVER DETAILS

NAME.....

DIVE QUALIFICATION.....

NO. OF YEARS DIVING.....

NO OF DIVES TO DATE.....

ARE YOU CONTINUING YOUR DIVE TRAINING? yes/no

DIVE CLUB (IF APPLICABLE).....

DOES YOUR CLUB HAVE IT'S OWN BOAT? yes/no RIB/hard (delete)

HAVE YOU DIVED WITH HWTMA BEFORE? yes/no

If yes please describe.....
.....

WHAT TYPE OF DIVING DO YOU NORMALLY DO?

Tick all that apply.

- | | | | |
|----------------|--------------------------|---------------------|--------------------------|
| COMMERCIAL | <input type="checkbox"/> | OTHER | <input type="checkbox"/> |
| ARCHAEOLOGICAL | <input type="checkbox"/> | Please specify..... | |
| BRITISH WATERS | <input type="checkbox"/> | | |
| WARM WATERS | <input type="checkbox"/> | | |
| TECHNICAL | <input type="checkbox"/> | | |
| WRECK | <input type="checkbox"/> | | |
| PHOTOGRAPHY | <input type="checkbox"/> | | |

ON AVERAGE, HOW MANY DIVES WOULD YOU DO IN A YEAR?

- 1-10 11-30 31-50 50+

HOW MUCH WOULD YOU NORMALLY PAY FOR A SINGLE BOAT DIVE?

- £10-20 £20-30 £30-35 £35+

SECTION 2 – THE ALUM BAY DIVE TRAIL

Please answer each of the following statements to indicate the extent to which you agree or disagree.

1 means you don't agree at all, to 5 which means you agree strongly. Please circle the appropriate number.

- i) The numbered orange buoys marking the stations are easy to spot.
1 2 3 4 5

- ii) It was easy to navigate from one station to the next without getting lost.
1 2 3 4 5

- iii) It was easy to navigate along the edge of the reef between the two areas of the site without getting lost.
1 2 3 4 5

- iv) The booklet is easy to handle and read underwater.
1 2 3 4 5

- v) It was easy to work out what I was seeing at each station using the information in the booklet.
1 2 3 4 5

- vi) The information in the booklet gave me a better understanding of the wreck site.
1 2 3 4 5

- vii) I enjoyed diving the site and found the wreck interesting.
1 2 3 4 5

- viii) I would recommend the site and dive trail to other divers.
1 2 3 4 5

ANY OTHER COMMENTS (Good or bad – please be honest!)

.....
.....
.....
.....
.....
.....

SECTION 3 – THE NEEDLES DIVE TRAIL

Please answer each of the following statements to indicate the extent to which you agree or disagree.

1 means you don't agree at all, to 5 which means you agree strongly. Please circle the appropriate number.

- i) The numbered white buoys marking the stations are easy to spot.
1 2 3 4 5

- ii) It was easy to navigate from one station to the next without getting lost.
1 2 3 4 5

- iii) The booklet is easy to handle and read underwater.
1 2 3 4 5

- iv) It was easy to work out what I was seeing at each station using the information in the booklet.
1 2 3 4 5

- v) The information in the booklet gave me a better understanding of the wreck site.
1 2 3 4 5

- vii) I enjoyed diving the site and found the wreck interesting.
1 2 3 4 5

- viii) I would recommend the site and dive trail to other divers.
1 2 3 4 5

ANY OTHER COMMENTS (Good or bad –please be honest!)

.....
.....
.....
.....
.....
.....
.....
.....
.....
.....
.....

SECTION 4 – THE DIVE BOAT

NAME OF BOAT.....

SKIPPER.....

DID YOU CONSIDER THIS BOAT TO HAVE ADEQUATE EQUIPMENT AND FACILITIES FOR THIS DIVE ?

YES/NO

COMMENTS.....

.....

.....

DID YOU FEEL YOU WERE WELL BRIEFED ON THE FOLLOWING:

BOAT FACILITIES AND ETIQUETTE yes/no

SAFETY CONSIDERATIONS yes/no

DIVE PLAN yes/no

TIDE AND CURRENT CONDITIONS yes/no

WATER ENTRY AND EXIT PROCEDURES yes/no

EMERGENCY PROCEDURES yes/no

DID THE BOAT SKIPPER APPEAR COMPETANT AND KNOWLEDGEABLE ABOUT LOCAL WATERS

YES/NO

COMMENTS.....

.....

.....

WOULD YOU BE HAPPY TO DIVE FROM THIS BOAT AGAIN?

YES/NO

ANY OTHER COMMENTS.....

.....

.....

.....

.....